

OPERATION INSTRUCTIONS

1. Make sure the feeder is empty and determine what kind of seed you want to serve. The feeder comes ready to fill with mixed or sunflower seed (not included). To adjust the ports to serve thistle/nyjer seed (not included), simply snap the inserts (A) into the main ports from the outside of the feeder.

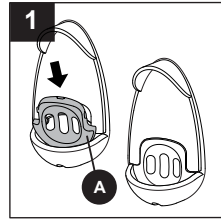

2. To convert the feeder back to a mixed or sunflower seed feeder, push the bottom of the insert (A) with your thumb until it pops out. Or, open the feeder and push the insert (A) with your finger from behind until it pops out.

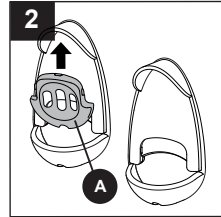

3. Slide the top away from the feeder along the hanger cable. Pour seed into the bird feeder. Slide the top back down onto the feeder.

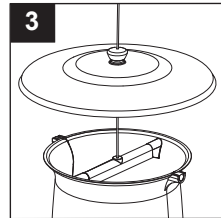

4. Adjust the perches on feeder by sliding the perch in or out to accommodate smaller or larger birds. Observe the birds that go to the feeder and adjust if needed.

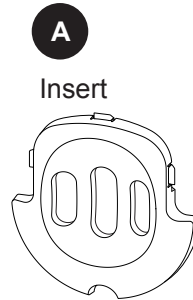
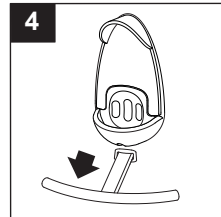

EASY TO CLEAN

- To clean the bird feeder, slide the top away from the feeder along the hanger cable. Push down on the hanger bar at the end of the cable until it releases from the feeder tubes, twist sideways and lift out. The bottom of the feeder has two “release buttons”. Push these in and gently pull the bottom of the base apart. Note: The feeder hinges at the top. Once the base is separated, simply unhinge the top and you are ready to clean. Hand wash with warm water and a mild antibacterial soap. The feeder can be placed in the top rack of your dishwasher. Rinse thoroughly and let dry completely. To reassemble the feeder, position the hinges at the top back in place and gently close the two halves together, making sure the release buttons at the bottom are firmly back in place. Place hanger bar back into the slot and reattach lid.

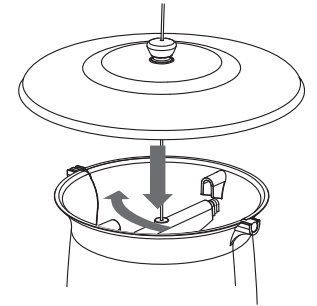

RELEASE AT BOTTOM OF FEEDER

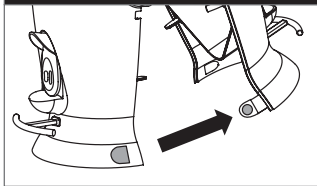

UNHINGE AT TOP OF FEEDER

